

## SECTION 6 - INSTALLATION OF ENGINE AND GEARBOX (SIGMA 150)

### TABLE OF CONTENTS

Para		Page
1	Preparation .....	2
2	Screen wash/wipe .....	2
7	Engine preparation .....	2
10	Chassis preparation .....	3
17	Installation of engine/gearbox into chassis (Warnings) .....	4
27	Electrical connections .....	5
39	Fuel system.....	6
41	Clutch hydraulic hose.....	6
43	Exhaust system.....	7
53	Cooling system (Caution) (Warning).....	9
65	Water bleed hoses .....	11
67	Heater and associated hoses.....	11
76	Throttle cable fitment .....	13
78	Breather pipe fitment.....	14
Table		
1	Special tools required .....	2
2	Torque figures .....	4
Fig		
1	Washer bottle bracket.....	2
2	J shape end of long hose.....	3
3	Horn location.....	3
4	ECU and MAP unit.....	5
5	Brake light switch harness .....	5
6	Fuel pipe connection.....	6
7	Clutch master cylinder hose union.....	6
8	Clutch hydraulic hose.....	6
9	Exhaust mounting .....	7
10	Primary pipes and collector/catalyst .....	7
11	Lambda probe connection .....	8
12	Exhaust arrangement.....	8
13	Breather bottle mounting bracket.....	9
14	Bottom hose engine connection .....	9
15	Radiator cowl flaps.....	10
16	Standard radiator arrangement.....	10
17	SV radiator arrangement .....	10
18	Coolant expansion bottle mounting bracket .....	11
19	Heater installation .....	11
20	coolant hoses.....	12
21	Heater valve arrangement .....	12
22	Heater control location .....	12
23	Heater control cable.....	13
24	Heater control cable attachment.....	13
25	Throttle cable linkage.....	14
26	Throttle cable to throttle body .....	14
27	Breather pipe .....	14
28	Engine bay overview.....	15

## SECTION 6 - INSTALLATION OF ENGINE AND GEARBOX (SIGMA 150)

### PREPARATION

1 The special tools detailed in Table 1 will be required.

**TABLE 1 SPECIAL TOOLS REQUIRED**

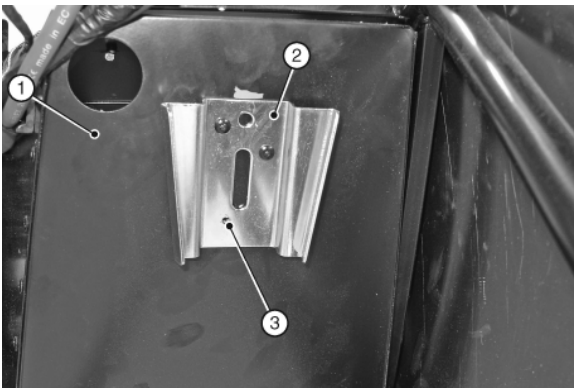
Item	Description
Engine hoist and sling	SWL of 150 Kg (min)

### Screen wash/wipe

*NOTE*

*The bracket for the washer bottle must be fixed to the front of the passenger side foot box before the engine is installed.*

2 Offer up the bracket with the washer bottle attached and mark the position of the two fixing holes. Remove the bracket and bottle and drill the marked positions using a 3/16" drill. Secure the bracket with rivets. Drill a third hole through the bracket and foot box, refer to Fig 1. Secure the third hole with a rivet and fit the washer bottle.



- 1 Footbox
- 2 Washer bottle bracket
- 3 Third hole

Fig 1 Washer bottle bracket

3 Remove the securing nut from the base of the washer jet (polythene bag marked 'miscellaneous') and pass the washer jet through the hole in the centre of the scuttle and secure with the plastic securing nut. Fit the clear plastic tubing to the washer jet. Dip the end of the clear plastic tubing in hot water to soften in order to make fitting easier.

4 Route the clear washer tubing along the wiring loom behind the dashboard and attach using cable ties, to prevent it falling down into view. Pass it down through the large grommet in the top of the transmission tunnel and along the engine bay diagonal tube until in line with the washer bottle. Trim the tube to length and attach to the washer motor.

5 Connect the washer motor to the wiring loom via the two pin plug adjacent to the washer bottle mounting. To ease fitment of the two pin plug the washer motor can be removed from the washer bottle, the two pin plug fitted and the washer motor reinserted into the washer bottle.

6 The windscreen wipers must not be fitted until the wiper motor has been run and allowed to park in order to prevent damage to the paintwork. Fit the wiper arms so that they are horizontal when parked. The wiper arms must move smoothly through their range of travel.

*NOTE*

*A small amount of water splashed on the windscreen will prevent the wiper blades from juddering during test and adjustment.*

### Engine preparation

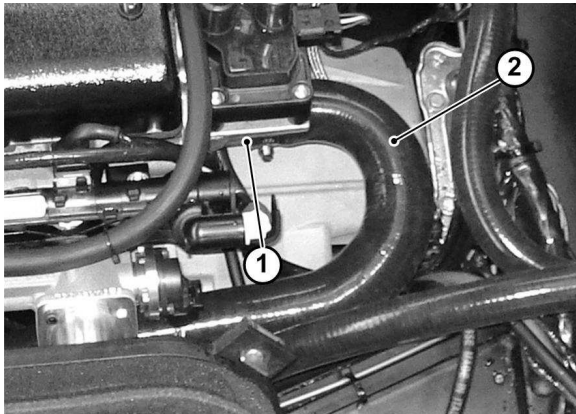
7 The large pre-formed long hose should be fitted onto the aluminium water outlet located on the rear of the cylinder head, refer to Fig 2. Pass the straight end of the hose under the throttle butterfly. Apply rubber lubricant to the 'J'-shape end of the hose (hose may require trimming) and push over the outlet; twist the hose until the long end sits along the LH side of the engine under the throttle butterfly. Secure using a hose clip (Refer cooling Z pack for clips).

8 Pass the other end hose under the throttle butterfly to the front of the engine, along the side of the alternator.

*NOTE*

*If the large pre-formed hose is not supplied with the kit, then there will be three hose supplied which need to be connected together using connectors and jubilee clips to make one piece long hose. The connectors and jubilee clips are supplied in cooling pack.*

## SECTION 6 - INSTALLATION OF ENGINE AND GEARBOX (SIGMA 150)



- 1 Engine connection
- 2 long hose

Fig 2 'J' shape end of long hose

9 Remove and retain the gearbox filler plug. Remove the plastic plug from the gearbox tailshaft housing. Removal of these plugs is not essential; however access is restricted within the confines of the transmission tunnel.

### Chassis preparation

10 Protect the appearance of the engine bay chassis tubes and pedal box sides and edges by covering with card and/or masking tape.

11 Ensure that all wires and connector plugs are secured and will not snag or catch the engine/gearbox as it is lowered.

### NOTE

*Before fitting engine mounting rubber blocks (polythene bag marked 'miscellaneous') ensure that the large threaded (1/2" UNF) boss in the centre is clear of rubber and that the bolt will thread in cleanly.*

12 Fit the engine mounting rubber block to the RH side of the engine bay. The two bolts (fastener pack 30P012A Item 3), plain washer (12) are passed downwards through the mounting, through the chassis and are secured with nyloc nuts (9) and plain washers (12). Do not tighten.

13 Fit the engine mounting rubber block to the LH side of the engine bay, locate the engine earth lead (a black lead approximately 300 mm long), pass bolt (2) and washer (12) downwards through the lead, through the front hole of the engine mounting block, through the chassis and secure with nyloc nut (9) and plain washer (12). Remove a little paint from the chassis/mounting to ensure that a good electrical contact is made. Pass bolt (3), plain washer (12) downwards through the rear hole of the engine mounting block, through the chassis and secure with nyloc (9) and plain washer (12). Do not tighten.

14 Locate the twin electric horns on the two studs near the rear edge of the steering rack platform. Before fitting the horns, loosen the 13 mm nut in the centre of each horn, this will allow rotation of the horns so that the electrical connections are closer together.

15 Secure the horns with the nyloc nuts provided and ensure that it is not possible for the horns to come into contact with each other, the steering rack or other components in the engine bay refer to Fig 3.



Fig 3 Horn location

16 Tighten the 13 mm nut in the centre of each horn and connect the horns to the electrical harness by the purple and yellow wires and connectors located above the horns on the front upper cross member.

## SECTION 6 - INSTALLATION OF ENGINE AND GEARBOX (SIGMA 150)

### INSTALLATION OF ENGINE/GEARBOX INTO CHASSIS

*NOTE*

*If the optional oil/air separator tank is to be installed then the mountings for the separator tank must be fitted before the engine is installed and the horns must be relocated to an alternate position beneath the coolant expansion bottle (refer to Section 16).*

**WARNINGS**

**(1) Never work underneath a car without supporting it on axle stands or equivalent. Do not rely on a jack alone.**

**(2) Use appropriate eye protection whilst working under the car.**

17 Using the lifting hoist and sling detailed in Table 1, attach the engine/gearbox using the lifting eyes provided on the engine, lower the engine/gearbox assembly into the engine bay at an angle of between 30-40° (with the engine higher than the gearbox). Insert the gearbox assembly into the transmission tunnel.

18 Continue to slide the engine/gearbox rearward until the holes in the gearbox mounting line up with the holes in the chassis cross member. If the differential and propshaft have already been fitted, ensure that the propshaft locates into the gearbox tailshaft housing.

19 Attach the LH engine mounting using the two M8 x 25 mm bolts (fastener pack 36G006A Item 4) and one M8 x 30 mm bolt (5), do not fully tighten the bolts.

20 Attach the RH engine mounting using the two M8 x 35 mm bolts (6) and one M10 x 40 mm bolt (2). Do not finally tighten the engine mounting retaining bolts until advised later in this section.

21 Lower the engine onto the rubber engine mountings and pass the bolts (fastener pack 30P012A Item 1 (LHS) and 21 (RHS)) down through the tube on the outer end of the engine mounting brackets. Screw the bolts loosely into the threaded bush in the centre of the rubber engine mounting. It is recommended that the engine is not removed from the hoist until all the bolts have been tightened (detailed later in this section).

22 Adjust the gearbox on its slotted mountings to achieve equal clearance within the transmission tunnel. This must be checked carefully as clearances are tight and poor alignment can cause the gearbox to contact the chassis under cornering.

23 Bolt the gearbox mounting rubber to the chassis using bolts (fastener pack 30P012A Item 4) passed down through the outer metal part of the rubber mounting and then through the elongated holes in the chassis. Secure with a plain washer (12) and nyloc nut (9) on each bolt and tighten to 20 Nm.

24 Finally tighten the fixings detailed in Table 2.

**TABLE 2 TORQUE FIGURES**

Fixing	Torque
Engine mounting to block	34 Nm
Engine mounting to mounting rubbers	41 Nm
Engine mounting rubbers to chassis	20 Nm
Gearbox mounting rubber to chassis	20 Nm

*NOTES*

(1) *It is now safe to remove the engine hoist.*

(2) *Wiring – Every effort is made to clearly explain and identify all the electrical connections as you go through this section; however the loom fitted to your car may have additional wires and connectors that are not required on your vehicle. To help clarify this, a wiring diagram can be found in section 17.*

25 Fit the gear lever to the top of gearbox tailshaft housing and secure with three setscrews (7). No washers are required; tighten to a torque of 20 Nm.

26 Fit the reverse light switch (polythene bag) into the side of the gearbox. This can be accessed via the hole in the RH side of the transmission tunnel. The switch should be inserted finger tight and then tightened a further quarter of a turn using a suitable sized spanner. Connect the wiring loom to the reverse light switch. From the cockpit, insert the large grommet (polythene bag) to cover the access hole in the transmission tunnel.

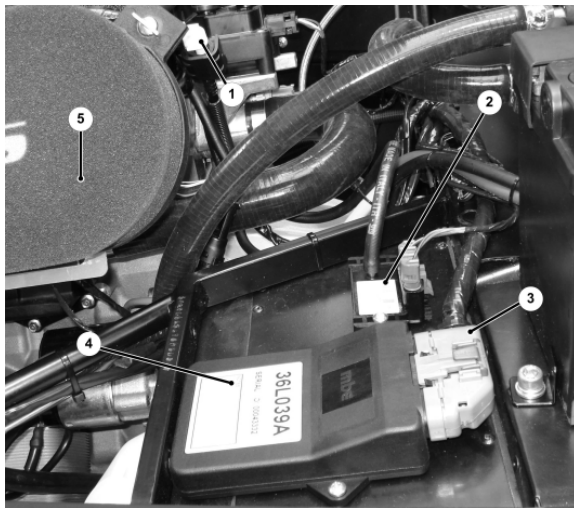


## SECTION 6 - INSTALLATION OF ENGINE AND GEARBOX (SIGMA 150)

### ELECTRICAL CONNECTIONS

27 The engine wiring loom is already attached to the engine and some ancillaries, however it is necessary to link the engine wiring loom to the remaining ancillaries and the vehicle wiring loom. All the plastic connecting plugs are matched pairs so it is not possible to connect them incorrectly.

28 Attach the grey, multi-pin plug to the respective socket on the Engine Control Unit (ECU), which is located on the passenger side heater tray, forward of the battery. Make the connection and ensure that the red retaining clip is pushed fully home, refer to Fig 4.



- |                        |                  |
|------------------------|------------------|
| 1 Fuel pipe connection | 3 Multi-pin plug |
| 2 MAP unit             | 4 ECU            |
|                        | 5 Air filter     |

Fig 4 ECU and MAP unit

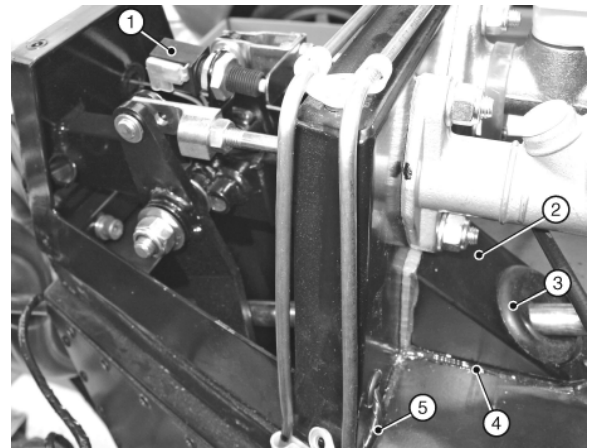
29 Position the MAP unit adjacent to the ECU and secure using two screws provided (fastener pack ZCH01 items 12 and 13).

30 Connect the green 3-pin plug on the engine loom to the connection on the MAP unit. Connect the short pipe on the MAP unit to the corresponding connection on the throttle body using the rubber vacuum hose provided.

31 Connect the white/brown wire from the vehicle loom to the oil pressure sender on the LH side of the engine block.

32 The two, paired, black/yellow wires with ring terminals in the engine loom are earth connections. Attach both pairs to a suitable earth point on the bulkhead.

33 The green, green/purple pair (with grommet) in the engine loom is for the brake light switch. The brake light switch is inside the drivers pedal box and the harness may be connected during installation of the steering column, refer to Section 3. Pass the brake light switch harness through the hole in the rear of the pedal box, refer to Fig 5 and push the two female connectors onto the male connectors of the brake light switch (orientation is not important). Fit the grommet into the hole and ensure that the harness will not foul the steering column or pedals.



- |                      |                              |
|----------------------|------------------------------|
| 1 Brake light switch | 4 Sealant                    |
| 2 Cheese wedge       | 5 Brake light switch harness |
| 3 Grommet            |                              |

Fig 5 Brake light switch harness

34 The longest wire from the engine loom (terminating in a 4-pin plug) is the connection for the exhaust mounted lambda probe. This cannot be connected until the exhaust primary pipes and collector/catalyst is fitted, refer to Para 50.

35 Remove the outermost starter motor securing bolt and spring washer. Pass the starter motor mounting bolt and attached spring washer through the black battery earth lead and secure to the bell-housing. Tighten to 34 Nm.

36 Connect the red lead from the starter motor to the battery.

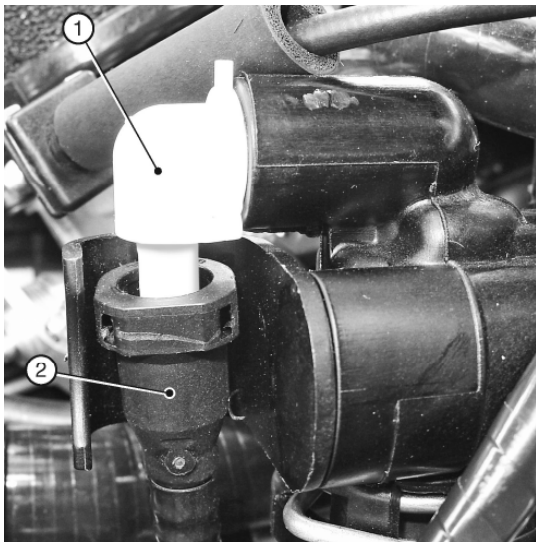
37 Connect the brown lead from the alternator to the starter.

38 Connect the brown/red wire from the chassis loom to the starter solenoid.

## SECTION 6 - INSTALLATION OF ENGINE AND GEARBOX (SIGMA 150)

### FUEL SYSTEM

39 The black, corrugated plastic, high pressure fuel pipe from the fuel pump emerges from the transmission tunnel and is a push-fit on the white elbow connection at the rear of the fuel rail, refer to Fig 6. Note that there is no fuel return pipe with this system.



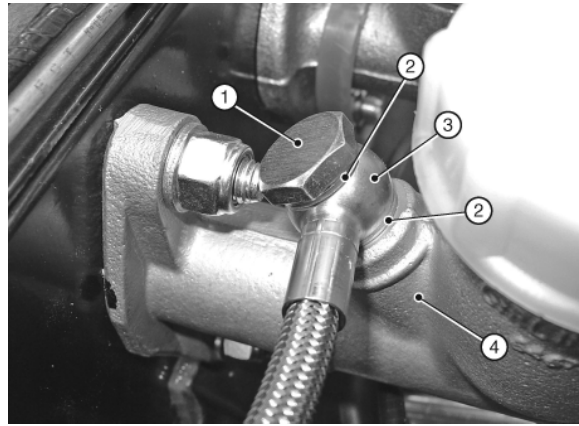
- 1 Fuel rail connection
- 2 Fuel pipe (from pump)

Fig 6 Fuel pipe connection

40 Once fitted the pipe cannot be removed without a special tool. Ensure that the pipe is kink free and routed away from possible snags or chafe points. Push the connection on the pipe firmly onto the elbow and check that it is securely attached. Secure the pipe with cable ties if necessary.

### CLUTCH HYDRAULIC HOSE

41 Remove all packaging from the clutch hydraulic hose. Fit a copper washer to the banjo bolt and pass the banjo bolt through the union at the end of the hose, refer to Fig 7. Fit the second copper washer to the banjo bolt and screw the banjo bolt into the clutch master cylinder outlet port (remove the port plug). Do not fully tighten the banjo bolt.



- 1 Banjo bolt
- 2 Copper washers
- 3 Hose union
- 4 Hose union
- 5 Clutch master cylinder

Fig 7 Clutch master cylinder hose union

42 Route the hose down the side of the pedal box, over the wiring loom (under the heater hose if fitted) and across the top of the bell-housing, Refer to Fig 8. Push the end of the hose into the connector in the clutch release bearing assembly and ensure that the hose is firmly attached. Secure the hose with cable ties if necessary, to prevent chafing and tighten the banjo bolt (the clutch system is filled and bled during start-up/final checks, refer to Section 14).



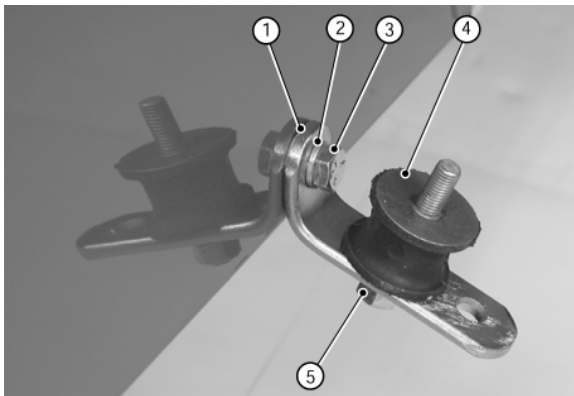
Fig 8 Clutch hydraulic hose

## SECTION 6 - INSTALLATION OF ENGINE AND GEARBOX (SIGMA 150)

### EXHAUST SYSTEM

43 The standard exhaust system consists of four primary pipes, a collector assembly which also incorporates the catalytic converter and a one piece silencer and tail pipe.

44 Bolt the exhaust mounting bracket (polythene bag marked 'exhaust') to the RH side of the car forward of the rear wheel, using setscrew (fastener pack 30X020A Item 1) and spring washers (3), refer to Fig 9. Secure the bobbin to the angle bracket with a nut (2) and spring washer (3).



- |   |               |   |        |
|---|---------------|---|--------|
| 1 | Angle bracket | 4 | Bobbin |
| 2 | Spring washer | 5 | Nut    |
| 3 | Setscrew      |   |        |

Fig 9 Exhaust mounting

45 Remove the exhaust gasket and associated fasteners from the RH side of the cylinder head, remove any masking tape protecting the exhaust ports and clean off any adhesive residue.

46 The exhaust primary pipes are marked with their part numbers:

#### Series 3

- 36X014A is for # 1 (front) cylinder.
- 36X015A is for # 2 cylinder.
- 36X016A is for # 3 cylinder.
- 36X017A is for # 4 (rear) cylinder.

47 Protect the area around the square aperture in the side panel with masking tape and card, place the exhaust gasket over the remaining studs and fit the primary pipes in the following sequence:

47.1 Pass the flanged end of # 4 pipe inwards, attach the flange loosely to the cylinder head and ensure that the pipe

sits in the bottom LH corner of the aperture (viewed from outside).

47.2 Pass the flanged end of # 1 pipe inwards, attach the flange loosely to the cylinder head and ensure that the pipe sits in the top RH corner of the aperture.

47.3 Pass the plain end of # 3 pipe outwards, attach the flange loosely to the cylinder head and ensure that the pipe sits in the bottom RH corner of the aperture.

47.4 Pass the plain end of # 2 pipe outwards, attach the flange loosely to the cylinder head and ensure that the pipe sits in the top LH corner of the aperture.

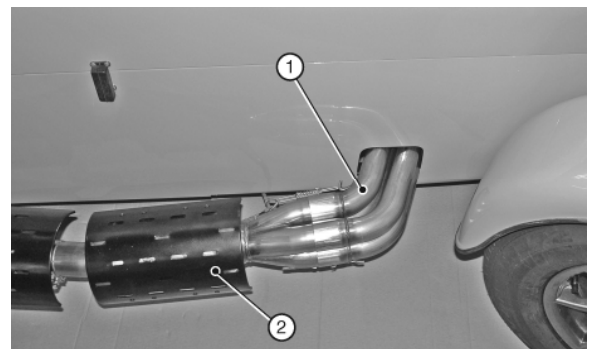
#### NOTE

*For series 5 use the same procedure to fit the primary, the sequence to fit the primary is 4,3,1,2*

- 56X005A is for #1 (front) cylinder.*
- 56X006A is for #2 cylinder.*
- 56X007A is for #3 cylinder.*
- 56X008A is for #4 (rear) cylinder.*

48 When the primary pipes are in place fit any remaining fasteners but do not tighten them.

49 Install the collector/catalyst over the assembled primary pipes with the threaded hole for the lambda probe faces towards the side panel. Secure the collector to the primary pipes with the two springs, refer to Fig 10. Support the weight of the collector such that the primary pipes are not in contact with the sides of the aperture and tighten the primary pipe/cylinder head fasteners to 34 Nm.



- |   |                                   |
|---|-----------------------------------|
| 1 | Primary pipe                      |
| 2 | Collector/catalyst (guard fitted) |

Fig 10 Primary pipes and collector/catalyst



## SECTION 6 - INSTALLATION OF ENGINE AND GEARBOX (SIGMA 150)

50 Fit the Lambda probe into the threaded hole in the collector/catalyst and connect the probe plug to the corresponding socket from the engine wiring loom. Secure the Lambda probe connection and wiring to the chassis ensuring that it cannot contact the hot exhaust or any moving part, refer to Fig 11.

### NOTE

*The lambda probe wiring passes under the side of the car below the lower chassis tube, it must not be routed through the primary pipe aperture in the side panel.*

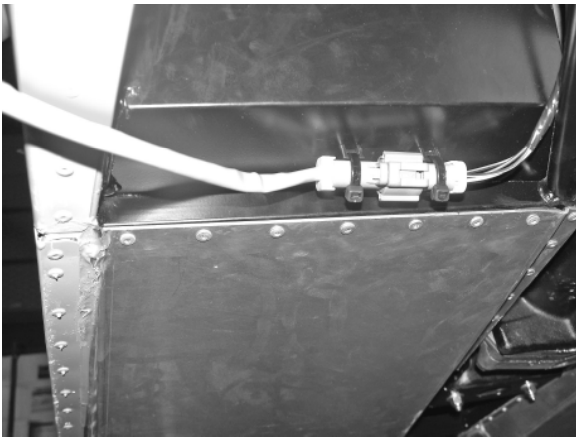


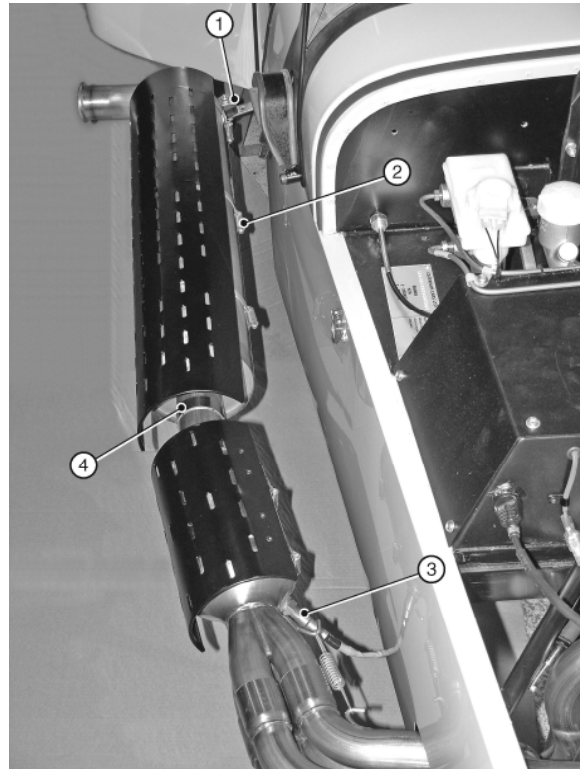
Fig 11 Lambda probe connection

51 Undo the large worm drive clips and feed them through the channels on the inside of the silencer and collector/catalyst guard. Fit the silencer guard to the silencer body with the channels offset towards the rear of the silencer and tighten the clips, refer to Fig 12. Ensure that the clip drives are not at the bottom of the silencer where they could contact the road. Attach the collector/catalyst guard in the same manner.

### NOTES

(1) *For a neater appearance position the clips with the drive screw towards the ground so that the clip 'tail' is out of sight beneath the exhaust.*

(2) *To reduce the risk of damage it is advisable to fit the silencer after the RH rear wing has been attached.*



1 Silencer bracket    3 Lambda probe  
2 Worm drive clip    4 Band clamp

Fig 12 Exhaust arrangement

52 Loosely fit the single band clamp to the front of the silencer and position the front of the silencer over the collector/catalyst outlet pipe. Locate the bracket at the rear of the silencer over the bobbin on the silencer mounting bracket and secure with a nut and spring washer. Tighten the nut and band clamp. It may be necessary to reposition the guards slightly.



## SECTION 6 - INSTALLATION OF ENGINE AND GEARBOX (SIGMA 150)

### COOLING SYSTEM

53 Position the breather bottle mounting bracket on the chassis as shown in the picture. Align the RHS hole on the bracket with the RHS rivet on the chassis and mark both hole. Drill the marked hole with 5/32" drill and fit the bracket in place using 5/32 rivets refer to fig 13. Push fit the breather bottle on to the mounting bracket.

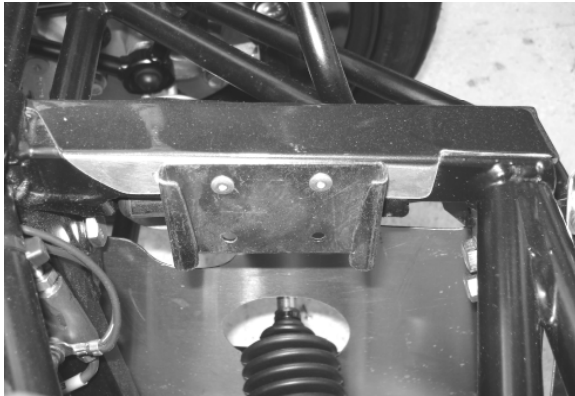
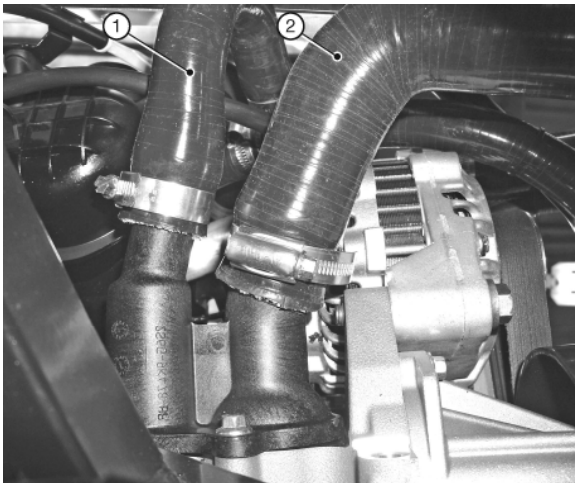


Fig 13 Breather bottle mounting Bracket

54 Position a hose clip on the flexible bottom radiator hose, apply rubber lubricant and fit the hose to the larger of the two outlets on the LH side of the engine block, Refer to Fig 14. The hose passes forwards along the LH side of the engine bay before turning to pass along the top of the steering rack and turns again to meet the radiator connection. Do not tighten the clip.



- 1 Small straight Hose to 'T' piece
- 2 Bottom radiator hose

Fig 14 Bottom hose engine connection  
(viewed from below)

55 Fit the four rubber radiator mountings to the front of the chassis and secure using nuts, plain washer and spring washers provided in the cooling pack.

56 Secure the fan to the inner cowl, ensuring that the fan electrical connector is located on the RH side, using four M6 setscrews and washers provided.

57 Secure the six rubber flaps (from polybag 'cooling') to the engine bay side of the inner cowl using the 5/32" rivets provided (two rivets per flap), refer to Fig 15. Fit the fan/cowl assembly to the rubber radiator mountings, ensuring that the cooling fan is closest to the engine bay, refer to Fig 16.

### NOTES

(1) The inner cowl must be fitted before the front anti-roll bar and the anti-roll bar must be fitted before the radiator, refer to Section 4.

(2) The four screws in the integral radiator mounting brackets are not required; they should be removed and discarded.



Fig 15 Radiator cowl flaps

## SECTION 6 - INSTALLATION OF ENGINE AND GEARBOX (SIGMA 150)

### CAUTION

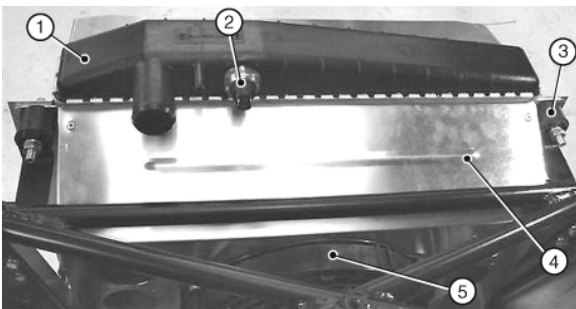
**Do not over tighten the blanking plug.**

58 Position the copper sealing washer on the blanking plug and fit the blanking plug into the threaded boss in the radiator, adjacent to the top hose connection.

### NOTE

*The blanking plug occupies the location previously used for a thermostatic fan switch. In the event that a switch is supplied in lieu of a blanking plug, fit the switch as described but **do not** connect it to the vehicle wiring harness.*

59 Fit the radiator and outer cowl onto the rubber radiator mountings ensuring that the hose connections face towards the engine. Secure using nuts, plain washers and spring washers.



- |                   |              |
|-------------------|--------------|
| 1 Radiator        | 4 Inner cowl |
| 2 Blanking plug   | 5 Fan        |
| 3 Rubber mounting |              |

Fig 16 Standard radiator arrangement

60 The radiator mounting arrangement on SV models differs considerably from that shown. SV kits include LH and RH radiator mounting plates, refer to Fig 17; these plates must be fixed to the body before attaching the rubber mountings and the radiator/inner cowl.

### NOTE

*Series 5 does not require outer radiator cowling*

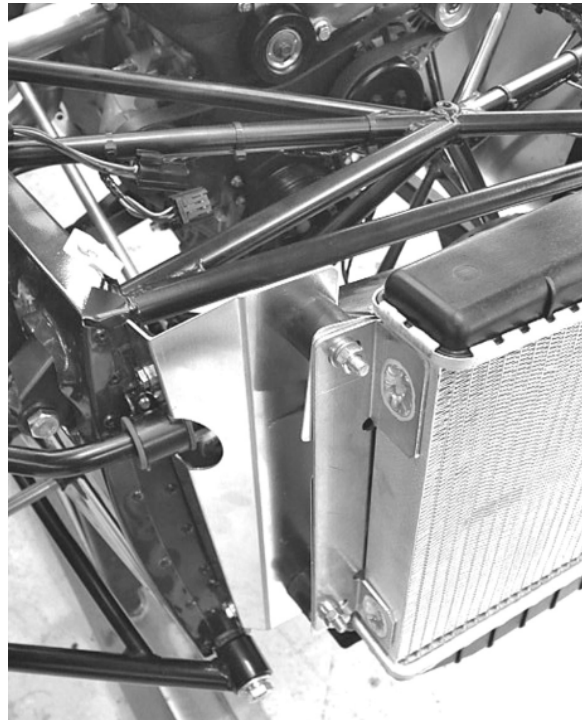


Fig 17 SV radiator arrangement

61 Position hose clips on the forward ends of the flexible top and bottom radiator hoses; apply rubber lubricant and fit the hoses over the connections on the radiator. Tighten the clips at both ends of both hoses.

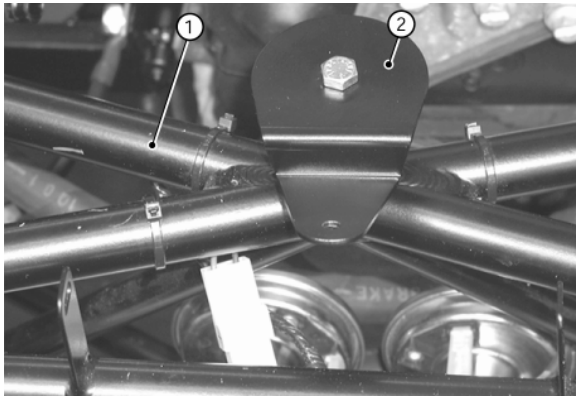
### NOTE

*The flexible radiator hoses may need to be trimmed to length.*

62 Locate the two-pin plug containing the black/green and black wires situated on the upper front diagonal chassis member. Connect the two-pin plug to the cooling fan electrical connector. Secure the cable to the chassis members using cable ties.

63 Fit the expansion bottle mounting bracket on the top of the cruciform, immediately behind the radiator, refer to Fig 18, and secure using bolt, plain washer and spring washer. Tighten to 11 Nm.

## SECTION 6 - INSTALLATION OF ENGINE AND GEARBOX (SIGMA 150)



- 1 Cruciform
- 2 Expansion bottle mounting bracket

Fig 18 Coolant expansion bottle mounting bracket

64 The round coolant expansion bottle sits on the mounting bracket and is secured using a setscrew, plain washer and nyloc nut; refer to Fig 28 for correct orientation of the expansion tank hose connections.

**NOTE**

*If an oil/air separator kit has been fitted the expansion bottle must be relocated, refer to Section 16.*

### Water bleed hoses

65 The smaller of the two inlets on the coolant expansion bottle connects to the stem of the small 'T' piece in the 5/16" bore hose that must connect the top of the radiator (near the blanking plug) to the small diameter connector at the rear RH side of the cylinder head, refer to Fig 28.

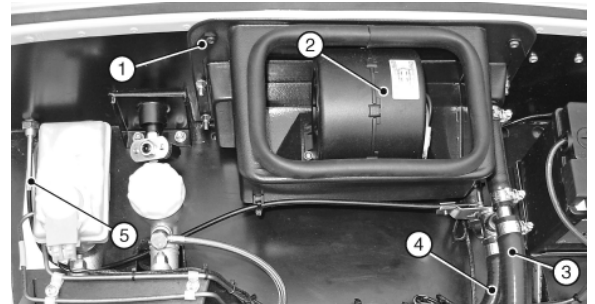
66 Route the 5/16" bore hose, back from the radiator to the 'T' piece and from the 'T' piece along the top radiator hose and fuel rail and around the back of the cylinder head. Cut pieces of 5/16" hose to length, apply rubber lubricant to each open end and fit to the connections and 'T' piece as described. Secure using hose clips. Secure the hose to the top radiator hose using cable ties.

### Heater and associated hoses

67 Remove and retain the four screws, nyloc nuts and washers and the two washer plates securing the diffuser panel to the heater. Position the diffuser panel on the inside surface of the scuttle and insert the four screws from the inside. Pass the heater harness through the large hole in the scuttle panel and locate the heater over the screws, secure with the washer plates, nyloc nuts, washers and two additional screws from the fastener pack, refer to Fig 19. Connect the heater harness connector heater to the matching plug, located under the dashboard.

**NOTE**

*Cars not fitted with a heater will be supplied with a blanking plate. Apply a small amount of silicon sealant around the edge of the plate to seal it.*



- |                     |                        |
|---------------------|------------------------|
| 1 Washer plate      | 4 Heater outlet hose   |
| 2 Heater            | 5 Heater control cable |
| 3 Heater inlet hose |                        |

Fig 19 Heater installation

68 Heater hose is supplied as four pre-formed pieces; one short straight, two long 'L' shape and one long 'J' shape:

68.1 The short straight hose connects the 'T' piece to the engine inlet next to the bottom radiator hose.

68.2 One of the long 'L' shape hose must be cut in two to provide a short straight hose (to connect the 'T' piece to modine) and a long 'L' shape (to connect the expansion tank to the 'T' piece). Measure the relevant distances carefully before cutting the hose.

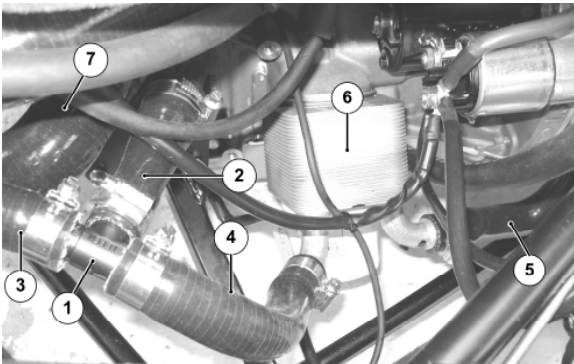
68.3 The other long 'L' shape hose may require cutting to the correct length to connect modine to heater outlet.



## SECTION 6 - INSTALLATION OF ENGINE AND GEARBOX (SIGMA 150)

68.4 The long 'J' hose connects the heater inlet to the water outlet at the rear of the cylinder head (next to the J shape end on large hose). This hose must be trimmed to length. Cut a 240 mm length of hose from the straight leg and cut this into two 120 mm pieces. Use the 120 mm pieces to connect the heater inlet and outlet to the heater valve, ref fig 21 and 28.

69 The larger of the two inlets on the coolant expansion bottle must connect to one end of the cross-bar of the large 'T' piece (near the alternator) that also connects to the modine and to the smaller of the two connections at the front LH side of the engine block, refer to Fig 20. Measure and cut the long, 5/8" bore, 'L' shaped hose as described at 67. Apply rubber lubricant to the hose and fit to the coolant expansion bottle and 'T' piece securing with a hose clip at each end.



- 1 large 'T'piece
- 2 small straight hose
- 3 hose to expansion bottle
- 4 hose to modine
- 5 hose modine to heater outlet
- 6 modine
- 7 bottom radiator hose

Fig 20 coolant hoses

70 Apply rubber lubricant and connect the short straight hose to the smaller of the two connections at the LH front of the engine block, connect this hose to the stem of the large 'T' piece. Secure using hose clips.

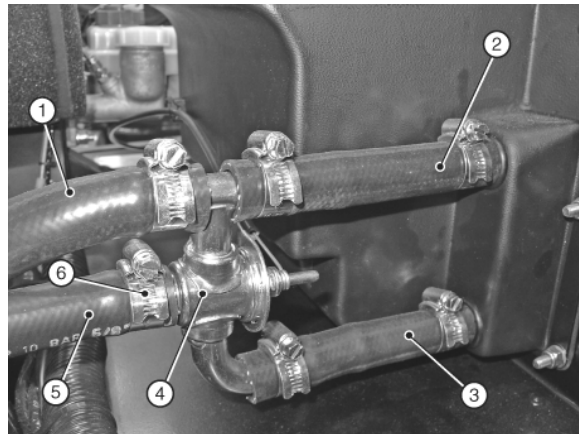
71 Use the cut length of 5/8" bore hose (from the long 'L' hose) to connect the remaining leg of the 'T' piece to the LHS end of the modine, refer to Fig 20. Connect the L shape end of the other 'L' shape hose to RHS end of the modine and

connect the other end to the heater valve inlet. Connect the other side of the heater valve upper/lower connection to the straight connectors on the heater using cut off hose of 120 mm length as mention in 68.4, trim the hose where necessary. Apply rubber lubricants where necessary and secure using hose clips. Ensure that the hose is routed to avoid chafing, use cable ties as necessary.

72 Trim to length and connect the long 'J' hose between the lower (inlet) connection of the heater valve and the outlet at the back of the cylinder head. Apply rubber lubricant where necessary and secure using hose clips. Ensure that the hose is routed to avoid chafing, use cable ties as necessary. Do not fully tighten the hose clips at the heater end at this point.

*NOTE*

*On cars where no heater is fitted the relevant connections at the rear of the cylinder head and on the front LH side of the engine block must be joined by a suitable length of hose.*



- |                  |                         |
|------------------|-------------------------|
| 1 Hose to modine | 5 Hose to cylinder head |
| 2 Heater outlet  | 6 Hose clip(s)          |
| 3 Heater inlet   |                         |
| 4 Heater valve   |                         |

Fig 21 Heater valve arrangement

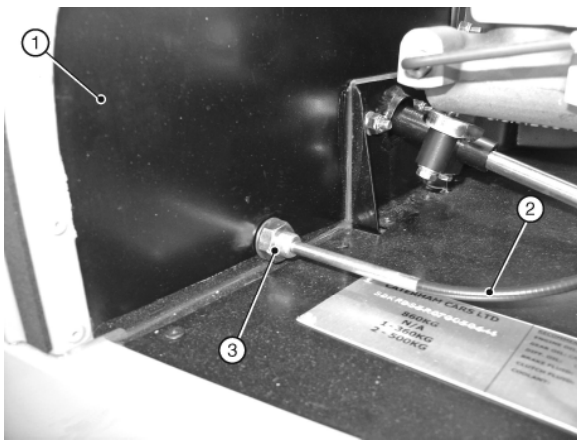
73 Remove and retain the locknut and washer from the heater control cable and pass it from inside the cockpit, through the hole in the front face of the scuttle, refer to Figs 22 and 23. Secure the cable in place using the locknut and washer provided.



## SECTION 6 - INSTALLATION OF ENGINE AND GEARBOX (SIGMA 150)

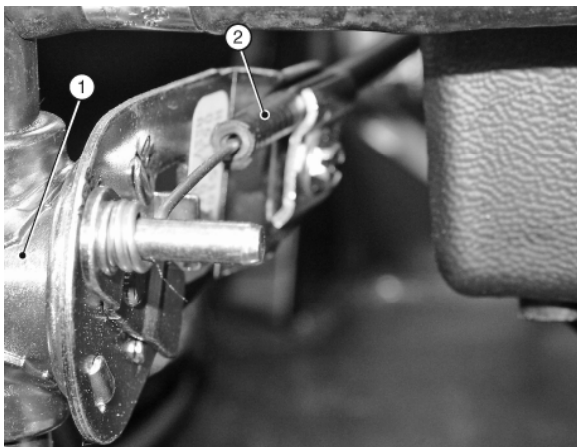


Fig 22 Heater control location



- 1 Scuttle panel
- 2 Heater control cable
- 3 Locknut

Fig 23 Heater control cable



- 1 Heater valve
- 2 Heater control cable

Fig 24 Heater control cable attachment

74 Connect the other end to the heater control valve by sliding the eyelet on the inner cable over the peg on the heater valve operating arm then slide the outer cable under the adjacent clamp and tighten the screw to secure in place, refer to Fig 24. Ensure that the valve travels through its full range when operated from inside the car. This can be adjusted by slackening the clamp that locates the outer cable to the valve and sliding the cable one way or another.

### WARNING

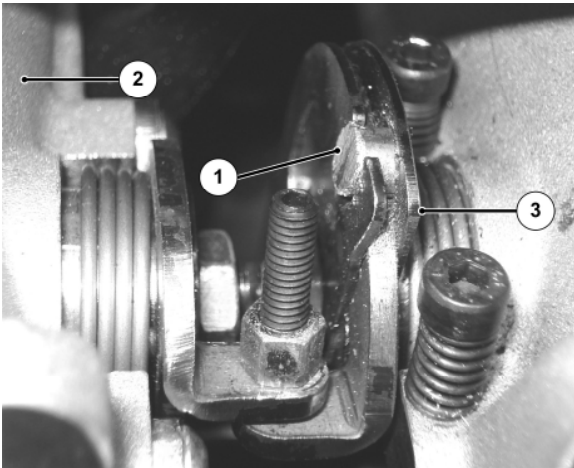
**Due consideration should be given to the highly flammable nature of petroleum or alcohol based products and their vapours. Serious burns can result from incorrect use.**

75 Fill the cooling system with a 50% antifreeze solution (refer to Owner's Handbook for Caterham recommended coolant). Add the coolant solution to the expansion bottle. Place paper or cloth on the scuttle in the area below the heater inlet/outlet hoses. Ensure that the heater valve is in the fully open position (control knob pulled towards the driver) and remove the heater inlet (top connector) hose which was previously left loose. Temporarily seal off the heater valve inlet and at the same time back fill the heater inlet hose with coolant solution. When the hose is full refit it to the heater inlet and secure with the hose clip. This procedure should minimise the amount of bleeding required once the engine is running for the first time.

### THROTTLE CABLE FITMENT

76 Attach the throttle cable to the linkage on the throttle body by engaging the nipple in the throttle operating lever and then clipping its square shaped black plastic adjuster onto the adjacent bracket. This adjuster can be threaded up and down the cable outer to adjust the throttle pedal position, refer to Fig 25, 26.

**SECTION 6 - INSTALLATION OF ENGINE AND GEARBOX (SIGMA 150)**



- 1 Throttle Cable nipple
- 2 Throttle Body
- 3 Throttle body linkage

Fig 25 Throttle cable linkage

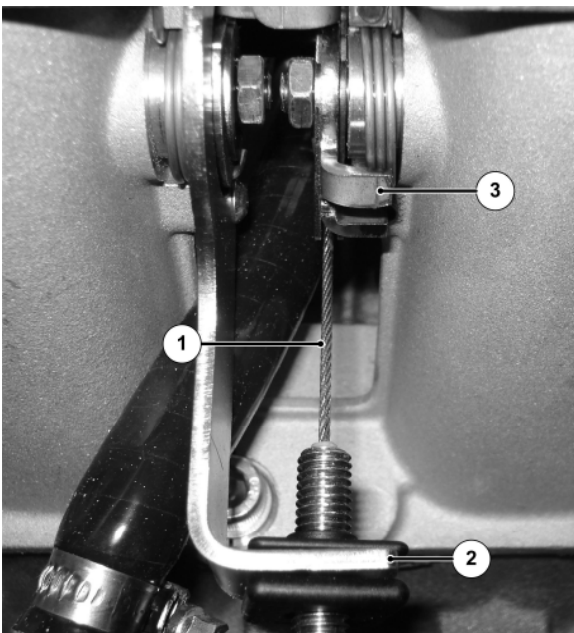
The top of the pedal should be gently squeezed with a pair of pliers to capture the cable and prevent it escaping.

**NOTE**

*In order to obtain a preferred pedal height and achieve adequate cable tension it may be necessary to bend the top of the pedal prior to locating the cable. This is done by inserting a Phillips screwdriver into the top of the pedal, bracing the bottom of the pedal with a block of wood, and gently bending the top of the pedal so as to take up the slack in the cable. Finally use the adjusting mechanism at the throttle body end of the cable to remove any free play.*

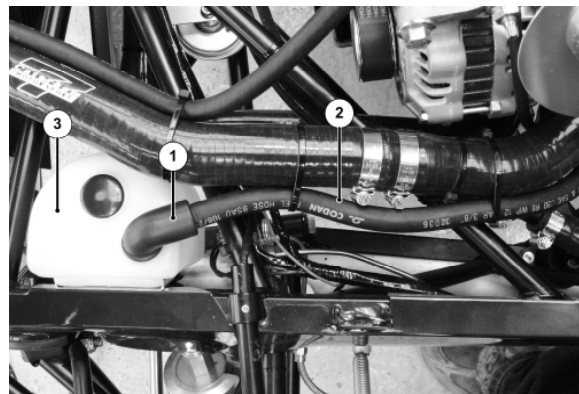
**BREATHER PIPE FITMENT**

78 Breather pipe is already fitted to the engine. Drill 20mm hole on the top of the breather bottle and fit the breather elbow refer to fig 26. Route the breather pipe along with the top radiator hose and fit to the breather elbow apply lubricant where necessary. Ensure that the pipe is routed to avoid chafing, use cable ties as necessary.



- 1 Throttle cable
- 2 Throttle cable adjuster
- 3 Throttle body linkage

Fig 26 Throttle cable to throttle body



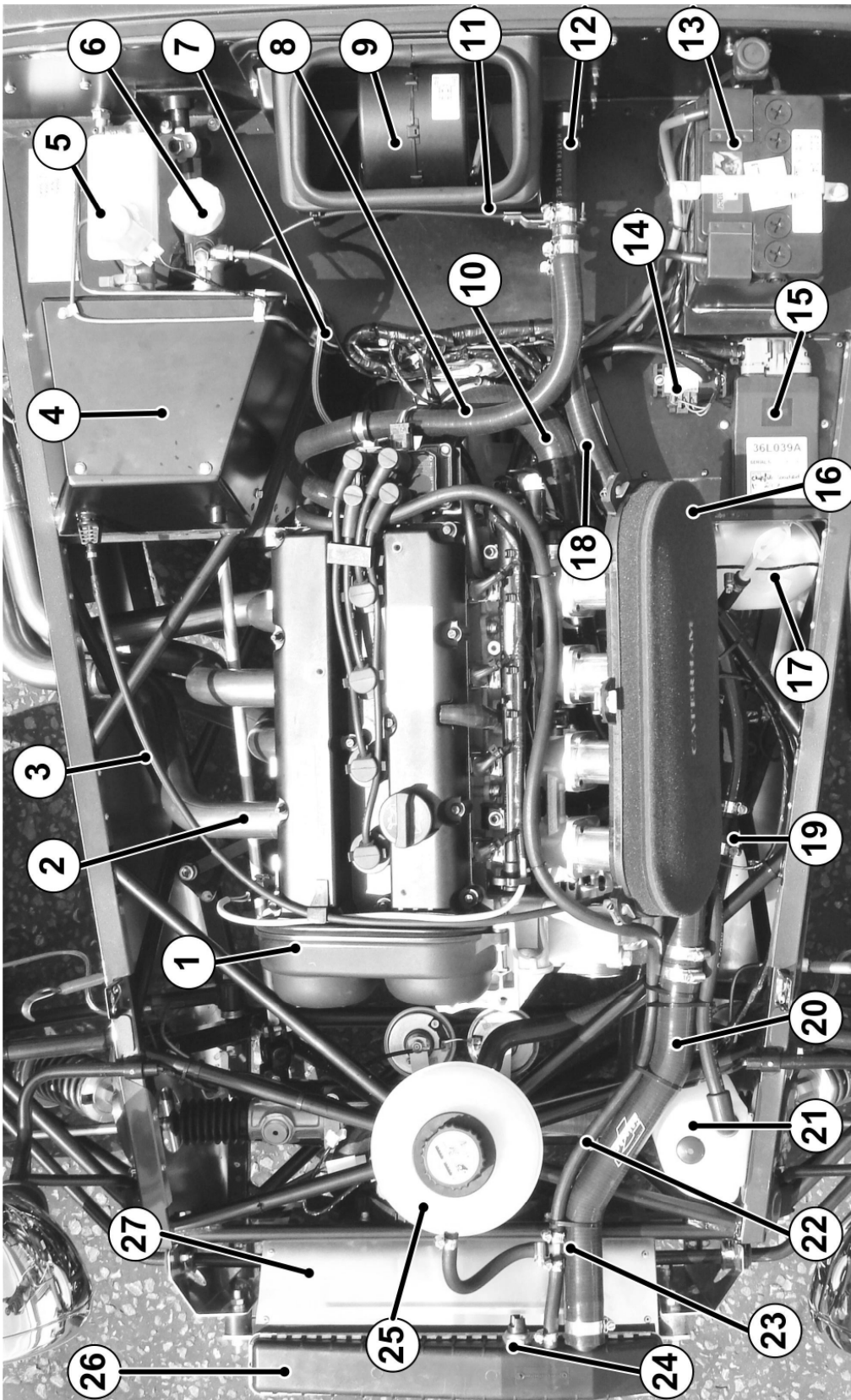
- 1 Breather elbow
- 2 Breather pipe
- 3 Breather bottle

Fig 27 Breather pipe

77 Route the other end of the cable around the front of the cam cover; refer to Fig 28 and through the 22 mm hole in the front of the pedal box and clip the plastic seat into place. The inner cable is fed into the slot on the top of the pedal with the portion of cable protruding past the cable termination located through the hole.



**SECTION 6 - INSTALLATION OF ENGINE AND GEARBOX (SIGMA 150)**



- |   |                        |    |                              |    |                     |
|---|------------------------|----|------------------------------|----|---------------------|
| 1 | Engine                 | 10 | large top radiator hose      | 19 | Large 'T' piece     |
| 2 | Exhaust primary pipe   | 11 | Heater control cable         | 20 | Top radiator hose   |
| 3 | Throttle cable         | 12 | Heater outlet                | 21 | Breather bottle     |
| 4 | Pedal box              | 13 | Battery                      | 22 | Water bleed hose    |
| 5 | Brake master cylinder  | 14 | MAP unit                     | 23 | Small 'T' piece     |
| 6 | Clutch master cylinder | 15 | ECU                          | 24 | Blanking plug       |
| 7 | Clutch hose            | 16 | Air filter                   | 25 | Expansion bottle    |
| 8 | Heater inlet hose      | 17 | Washer bottle                | 26 | Radiator            |
| 9 | Heater                 | 18 | Heater outlet hose to modine | 27 | Radiator inner cowl |

Fig 28 Sigma 150 Engine bay overview

PAGE INTENTIONALLY BLANK